



## Dräger X-am 2500 (MQG 0011) Technical Manual





## Content

<b>1</b>	<b>For your safety</b>	<b>4</b>	<b>6</b>	<b>Operation with pump</b>	<b>21</b>
1.1	General safety statements	4	<b>7</b>	<b>Replacing the sensors</b>	<b>21</b>
1.2	Definitions of alert icons	4	<b>8</b>	<b>Troubleshooting</b>	<b>22</b>
<b>2</b>	<b>Description</b>	<b>5</b>	8.1	Warning messages	22
2.1	Product overview	5	8.2	Fault message	24
2.1.1	Front	5	<b>9</b>	<b>Maintenance</b>	<b>27</b>
2.1.2	Rear side	5	9.1	Maintenance table	27
2.1.3	Display	5	9.2	Cleaning	27
2.1.4	Special symbols	5	<b>10</b>	<b>Storage</b>	<b>27</b>
2.2	Intended use	6	<b>11</b>	<b>Disposal</b>	<b>27</b>
2.3	Approvals	6	11.1	WEEE	27
2.3.1	Marking	6	11.2	Battery disposal	27
2.3.2	Permitted power packs	6	11.3	Electrochemical sensors	27
2.3.3	Safety Instructions	7	<b>12</b>	<b>Technical data</b>	<b>28</b>
<b>3</b>	<b>Use</b>	<b>8</b>	12.1	X-am 2500	28
3.1	Preparations for use	8	12.2	Sensor data	29
3.1.1	Charging the batteries	8	<b>13</b>	<b>Order list</b>	<b>31</b>
3.1.2	Replacing the batteries / rechargeable batteries	9	<b>14</b>	<b>Declaration of conformity</b>	<b>32</b>
3.1.3	Switching on the instrument	9			
3.1.4	Switching off the instrument	10			
3.2	Before entering the workplace	10			
3.3	Configuration	11			
3.3.1	Standard gas configuration	11			
3.3.2	Standard instrument configuration	12			
3.3.3	Configuring the device	12			
3.3.4	Export data memory and display graphically	13			
3.4	Running the bump test	13			
3.4.1	Manual implementation without documentation of the results in the instrument memory	13			
3.4.2	Menu implementation with the documentation of results in the instrument memory	14			
3.4.3	Automatic implementation with the Bump Test Station	14			
3.5	During operation	15			
3.6	Identifying alarms	15			
3.6.1	Concentration pre-alarm A1	15			
3.6.2	Concentration main alarm A2	16			
3.6.3	STEL / TWA exposure alarm	16			
3.6.4	Battery pre-alarm	16			
3.6.5	Battery main alarm	16			
3.6.6	Instrument alarm	16			
<b>4</b>	<b>Menu functions</b>	<b>17</b>			
4.1	Activating the Info mode	17			
4.2	Opening Info-Off Mode	17			
4.3	Quick Menu	17			
4.3.1	Quick menu functions	17			
4.3.2	Opening the Quick Menu	17			
4.3.3	Quick menu "Delete peak values"	17			
4.4	Calibration Menu	17			
4.4.1	Calibration menu functions	17			
4.4.2	Open the Calibration Menu	17			
<b>5</b>	<b>Calibrate instrument</b>	<b>18</b>			
5.1	Adjustment interval:	18			
5.2	Run fresh air calibration	18			
5.3	1-button calibration	19			
5.3.1	Calibrating the sensitivity for an individual measuring channel	19			
5.3.2	Sensitivity calibration for CatEx	20			

# 1 For your safety

## 1.1 General safety statements

- Before using this product, carefully read the associated Instructions for Use. This document does not replace the Instructions for Use.

## 1.2 Definitions of alert icons

The following alert icons are used in this document to provide and highlight areas of the associated text that require a greater awareness by the user. A definition of the meaning of each icon is as follows:



### **WARNING**

Indicates a potentially hazardous situation which, if not avoided, could result in death or serious injury.



### **CAUTION**

Indicates a potentially hazardous situation which, if not avoided, could result in physical injury, or damage to the product or environment. It may also be used to alert against unsafe practices.



### **NOTICE**

Indicates additional information on how to use the product.

---

## 2 Description

### 2.1 Product overview

#### 2.1.1 Front

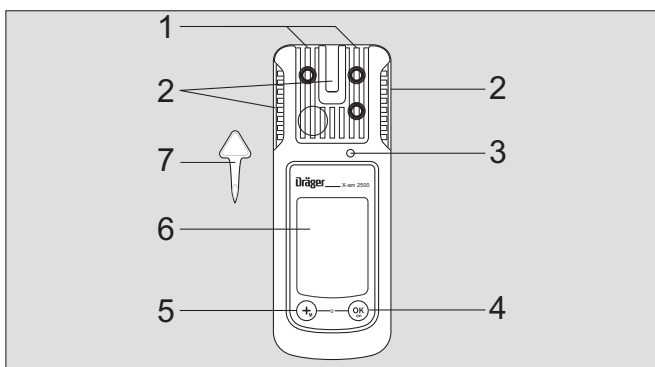

00133366.eps

- 1 Gas entry
- 2 Alarm LED
- 3 Horn
- 4 key
- 5 key
- 6 Display
- 7 Tool for changing sensor

#### 2.1.2 Rear side

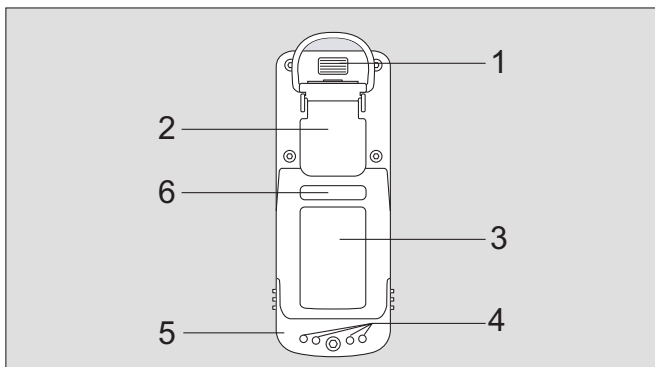

00233366.eps

- 1 IR interface
- 2 Fastening clip
- 3 Nameplate
- 4 Charging contacts
- 5 Power pack
- 6 Serial no.

#### 2.1.3 Display

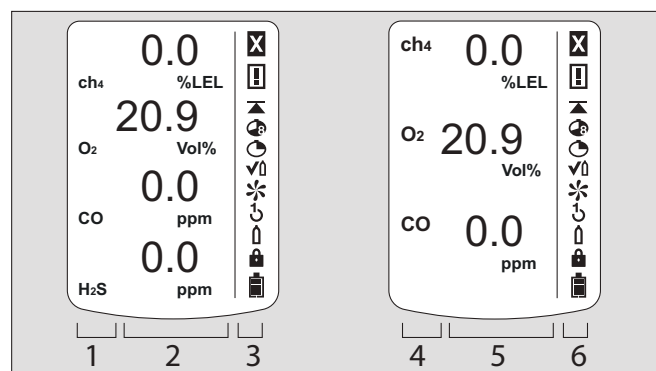

00333366\_en.eps

- Display for 4 measuring channels:
- 1 Measured gas display with unit
  - 2 Measuring value display
  - 3 Special symbols

otherwise:

- 4 Measured gas display
- 5 Measured value display with unit
- 6 Special symbols

The following only shows the instrument version with 4 measuring channels.

#### 2.1.4 Special symbols

- Fault message, see section 4.1 on page 17
- Warning message, see section 4.1 on page 17
- Display of peak values for all measured gases, see section 4.1 on page 17
- The exposure evaluation display (TWA) for measured gases, e.g. H<sub>2</sub>S and CO, see section 4.1 on page 17
- The exposure evaluation display (STEL) for measured gases, e.g. H<sub>2</sub>S und CO, see section 4.1 on page 17
- The instrument is set to the bump test function, see section 3.4 on page 13
- The instrument is set to the fresh air calibration function, see section 5.2 on page 18
- The instrument is set to the 1-button calibration/adjustment function, see section 5.3 on page 19
- The instrument is set to the single gas calibration function, see section 5.3.1 on page 19
- Function for password input is active, see section 4.4 on page 17
- Battery / rechargeable battery 100 % full
- Battery / rechargeable battery 2/3 full
- Battery / rechargeable battery 1/3 full
- Battery / rechargeable battery empty

## 2.2 Intended use

Portable gas detection instrument for the continuous monitoring of the concentration of several gases in the ambient air within the working area and in explosion-hazard areas. Independent measurement of up to 4 gases, in accordance with the installed Dräger sensors.

### Areas subject to explosion hazards, classified by zones

The instrument is intended for the use in areas that are at risk for explosions in Zone 0, Zone 1 or Zone 2 or in mines at risk due to black damp. It is intended for use within a temperature range of -20 °C to +50 °C, and for areas in which gases of explosion groups IIA, IIB or IIC and temperature class T3 or T4 (depending on the batteries and rechargeable battery) may be present. For zone 0, the temperature class is limited to T3. If used in mines, the instrument is only to be used in areas known to have a low risk of mechanical impact.

### Areas subject to explosion hazards, classified by divisions

The instrument is intended for the use in areas that are at risk for explosions of Class I&II, Div. 1 or Div. 2. It is intended for use within a temperature range of -20 °C to +50 °C, and for areas in which gases or dusts of groups A, B, C, D or E, F, G, and temperature class T3 or T4 (depending on the batteries and rechargeable battery) may be present.

## 2.3 Approvals

The approvals are shown on the rating plate. The technical approvals are valid for the X-am 2500 gas detection instrument and the calibration cradle. The explosion-protection approvals are only valid for the X-am 2500 gas detection instrument; the calibration cradle must not be used in the Ex zone. The BVS 10 ATEX E 080 X technical suitability test is based on the calibration with the target gas.

CE marking:	Electromagnetic compatibility (Directive 2004/108/EC)
	Explosion protection (Directive 94/9/EC)

## 2.3.1 Marking



Serial no.<sup>1</sup> on separate sticker

## 2.3.2 Permitted power packs

**Power pack 83 22 237;**  
**approved as type ABT 0100**  
 Temperature class T4  
 -20 °C ≤ Ta ≤ +50 °C  
 use with alkaline batteries  
 Duracell Procell MN1500<sup>2</sup>

Temperature class T3  
 -20 °C ≤ Ta ≤ +40 °C  
 use with NiMH rechargeable batteries  
 GP 180AAHC<sup>2</sup> (1800 mAh)

or with alkaline batteries  
 Varta Type 4006<sup>2</sup>  
 Varta Type 4106<sup>2</sup>  
 Panasonic LR6 Powerline

**NiMH power pack T4 (order no. 83 18 704);**  
**approved as HBT 0000**  
 Temperature class T4  
 -20 °C ≤ Ta ≤ +50 °C

**NiMH power pack T4 HC (order no. 83 22 244);**  
**approved as HBT 0100**  
 Temperature class T4  
 -20 °C ≤ Ta ≤ +50 °C

<sup>1</sup> The year of construction is coded by the third capital letter of the serial number: D = 2012, E = 2013, F = 2014, H = 2015, J = 2016, K = 2017, L = 2018, etc.

Example: Serial number AREH-0054, the third letter is E, so the year of manufacture is 2013.

<sup>2</sup> Not subject to BVS10 ATEX E 080X and PFG 10 G 001X performance approval.

### 2.3.3 Safety Instructions

**WARNING**

Do not replace or charge batteries in potentially explosive areas. Explosion hazard!

Charge the NiMH power pack T4 (type HBT 0000) or T4 HC (type HBT 0100) with the associated Dräger charger. Charge NiMH single cells for ABT 0100 battery holder in accordance with the manufacturer's specifications. Ambient temperature during the charging process: 0 to +40 °C.

To reduce the danger of explosion, do not mix new batteries with old batteries and do not mix batteries made by different manufacturers.

Always disconnect the instrument from the power pack before carrying out any maintenance operations.

Substitution of components may impair intrinsic safety.

Only use power packs ABT 0100 (order no. 83 22 237), HBT 0000 (order no. 83 18 704) or HBT 0100 (order no. 83 22 244). See marking on power pack for approved batteries and related temperature classes.

Not tested in an oxygen-enriched atmosphere (>21 % O<sub>2</sub>).

High off-scale readings may indicate an explosive concentration.

Note the following for CSA (Canadian Standards Association) applications:

For the CSA approval only the functions of the device component that is used to measure flammable gases are tested. The device is not approved by CSA for use in mining.

**WARNING**

Before daily use, test the sensitivity with a known concentration of the applicable gas corresponding to 25 to 50% of the maximum concentration. The accuracy must be within a range of 0 to +20% of the actual value. Perform a calibration to correct the accuracy if necessary.

## 3 Use

### 3.1 Preparations for use

- Before using the instrument for the first time, insert the batteries provided or a charged NiMH power pack T4 (type HBT 0000; order no. 83 18 704) / T4 HC (type HBT 0100; order no. 83 22 244), see section 3.1.2 on page 9.
- The instrument is now ready for operation.

#### 3.1.1 Charging the batteries



#### WARNING

Explosion hazard!  
Do not charge underground or in explosion hazard areas!

The chargers are not designed in accordance with the regulations for fire damp and explosion protection.

Charge the NiMH power pack T4 (type HBT 0000) or T4 HC (type HBT 0100) with the associated Dräger charger. Charge NiMH single cells for ABT 0100 battery holder in accordance with the manufacturer's specifications. Ambient temperature during the charging process: 0 to +40 °C.



#### NOTICE

Even if the instrument is not used, Dräger recommends storing the instrument in the charging cradle (charging module X-am 1/2/5000, order no. 83 18 639).

- To maintain the lifetime of the batteries, charging is temperature controlled and only performed in a temperature range of 5 to 35 °C. When outside this temperature range, the charging automatically interrupted and automatically recommenced after the temperature range has been reached again.
- The charging time is typically 4 hours.
- A new NiMH power pack reaches its full capacity after three complete charging/discharging cycles.
- Never store the instrument for extended periods without being connected to a power source (maximum of 2 months) because the internal buffer battery will drain.

#### Charging with the multiple charging station

- A maximum of 20 instruments can be charged at the same time on the power pack (order no. 83 18 805) of the multiple charging station.
- When attaching the charging modules, disconnect the power pack from the mains supply!



#### CAUTION

Always connect or disconnect the charging modules individually and not in groups in order to prevent the charging station from becoming damaged. During transportation, the power pack and the charging modules should also always be handled individually and without inserted instruments.

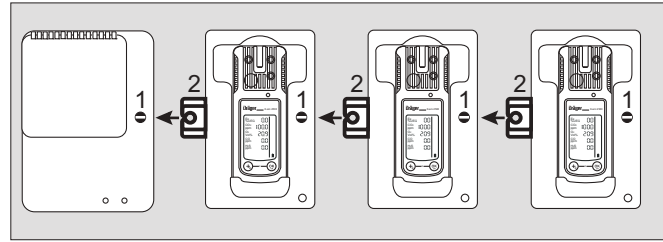

02733366.eps

- Position the instrument on an even and level surface.
  1. Turn the slots of the interlock into a horizontal position by using a screwdriver or coin.
  2. Insert the fastening lug (2) of the charger module (simultaneous power feed) until it engages.
  3. Close the lock (1) with a quarter turn (slot is positioned vertically).
  4. Attach additional charging modules in the same way.
  5. Connect the power pack to the mains.
    - The green "Mains" LED (1) is on.
  6. Insert the switched off instrument into the charging module.
    - Display LED (5) on the charging cradle:
      - ▬ Charging
      - ▬ Fault
      - ▬ Full
- If a fault occurs:
  - Remove the instrument from the charging module and insert it again.
- If the fault still occurs, have the charging module repaired.
  - It takes approx. 4 hours to fully charge an empty rechargeable battery.



#### CAUTION

A short circuit of the charging contacts in the charging modules, e. g., by metallic objects that have fallen in, does not result in damage to the charging station. It should, however, be avoided due to possible heating hazards and incorrect displays on the charger module.

- In the event of a short circuit or if the power pack is overloaded:
  - The red "Overload" LED (3) is on, and an audible alarm sounds.
  - After the fault has been corrected, the alarm is switched off automatically and the charging process is restarted.
  - In the event of a power failure, the instruments already charged will be protected from discharging.



## Charge using charger module and plug-in power pack or vehicle charging adapter

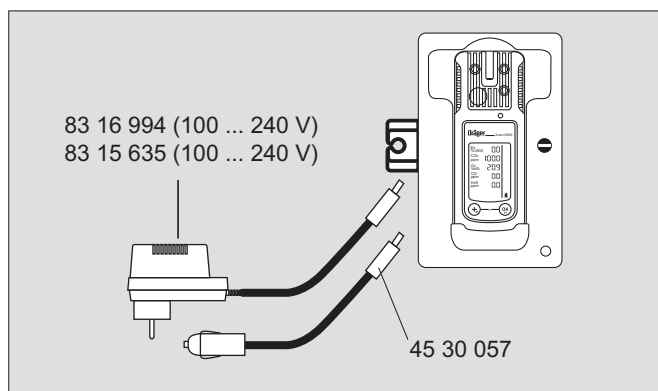

- When using the power pack (order no. 83 16 994), up to 5 instruments can be charged at the same time, with power pack (order no. 83 15 635) up to 2 instruments.
- The power pack contained in the rechargeable battery and charging set (order no. 83 18 785) is suitable for charging one instrument.
- When using the vehicle charging adapter (order no. 45 30 057) it is recommended that you supply every charging module separately.
- The charging process is carried out analogous to charging with the multiple charging station.

### 3.1.2 Replacing the batteries / rechargeable batteries



#### WARNING

Explosion hazard!  
Do not throw used batteries into fire or try to open them by force.

Do not replace or charge batteries in a hazardous area.

Batteries / rechargeable batteries are part of the Ex approval.

Only the following types may be used:

- Alkaline batteries – T3 – (non rechargeable!)
- Panasonic LR6 Powerline
- Varta Type 4106 <sup>1</sup> (power one) or
- Varta Type 4006 <sup>1</sup> (industrial)
- Alkaline batteries – T4 – (non rechargeable!)
- Duracell Procell MN1500 <sup>1</sup>
- NiMHy rechargeable batteries – T3 – (rechargeable)
- GP 180AAHC <sup>1</sup> (1800 mAh) max. 40 °C ambient temperature.

Charge the NiMH power pack T4 (type HBT 0000) or T4 HC (type HBT 0100) with the associated Dräger charger. Charge NiMH rechargeable batteries for battery holder ABT 0100 in accordance with the manufacturer's specifications. Ambient temperature during the charging process: 0 to +40 °C.

1) Not part of the measurement performance tests BVS10 ATEX E 080X and PFG 10 G 001X.

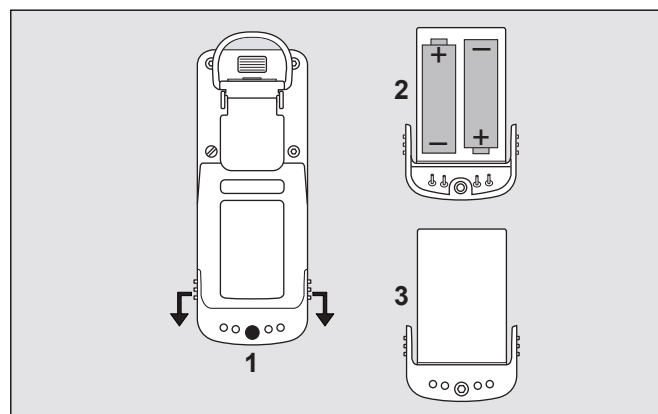

1. Switching off the instrument: **OK** key and **+** key are held down simultaneously.
2. Loosen the screw (2.0 mm hexagon socket) on the power pack and remove the power pack.
  - With battery holder (order no. 83 22 237): Replace alkaline batteries or NiMHy rechargeable batteries. Ensure correct polarity.
  - With the T4 NiMH power pack (type HBT 0000) / T4 HC (type HBT 0100): Completely replace the power pack.
3. Insert the power pack into the instrument and tighten the screw, the instrument switches on automatically.

After replacing the T4 NiMH power pack (type HBT 0000)/ T4 HC (type HBT 0100), a full charge is recommended.

#### After the batteries have been replaced:

- The settings and data are stored when the battery is replaced. The sensors warm up again.

### 3.1.3 Switching on the instrument

1. **Hold down the [OK] button** for approx. 3 seconds until the » **3 . 2 . 1** « countdown shown on the display has elapsed.
  - All the display segments, including the visual, audible and vibration alarms, are activated for a short time.
  - The software version is displayed.
  - The instrument performs a self-test.
  - The sensor that is up next for calibration/adjustment is displayed with the remaining days until the next calibration/adjustment e. g. » **Ex %LEL CAL 20** «.
  - The time until the bump test interval elapses is displayed in days, e.g. » **bt 123** «.
  - All A1 and A2 alarm thresholds and » **☼** « (TWA)<sup>1</sup> and » **☼** « (STEL)<sup>1</sup> for all toxic gases (e. g. H<sub>2</sub>S or CO) are displayed consecutively.
  - During the warm-up period of the sensors, the respective display of the measured value flashes and the special symbol » **☼** « (for warning) is displayed. No alarms are issued during the warm-up period of the sensors. See the Technical Handbook for details regarding accelerated warm-up.
2. Press the **[OK]** key to cancel the display of the activation sequence.

1 Only when activated in the instrument configuration. Delivery condition: not activated.

### 3.1.4 Switching off the instrument





- Press and hold the [OK] key and [ + ] key simultaneously until the countdown » 3 . 2 . 1 « shown on the display has elapsed.  
Before the instrument is switched off, the visual, audible and vibration alarms are activated for a short time.

## 3.2 Before entering the workplace



### WARNING

Before any measurements relevant to safety are made, check the adjustment with a bump test, adjust if necessary and check all alarm elements. If national regulations apply, a bump test must be performed according to the national regulations. Faulty adjustment may result in incorrect measuring results, with possible serious consequences.

1. Switch on the instrument. The current measured values are shown in the display.
2. Observe any warning »  « or fault messages »  «.
  -  The instrument can be operated normally. If the warning message does not disappear automatically during operation, the instrument must be serviced after the end of use.
  -  The instrument is not ready to measure and requires maintenance.
3. Check that the gas inlet opening on the instrument is not covered.



### WARNING

Fractions of catalytic poisons in the measuring gas (e.g. volatile silicone, sulphur, heavy metal compounds or halogenated hydrocarbon) can damage the CatEx sensor. If the CatEx sensor can no longer be calibrated to the target concentration, the sensor must be replaced.

In case of measurements in an oxygen-deficient atmosphere (<8 Vol.-% O<sub>2</sub>) the CatEx sensor may show incorrect displays; in this case, a reliable measurement with a CatEx sensor is not possible.

In an oxygen enriched atmosphere (>21 vol. % O<sub>2</sub>), the explosion protection cannot be guaranteed; remove instrument from the Ex area.

### 3.3 Configuration

#### 3.3.1 Standard gas configuration

DrägerSensor	Measuring range <sup>1)</sup>	Alarm A1 <sup>1)</sup>			Alarm A2 <sup>1)</sup>		
		threshold	can be acknowledged	self-latching	threshold	can be acknowledged	self-latching
CatEx 125 PR [%LEL]	0 to 100	20	yes	no	40	no	yes
XXS O <sub>2</sub> [Vol.-%]	0 to 25	19 <sup>2)</sup>	no	yes	23	no	yes
XXS CO [ppm]	0 to 2000	30	yes	no	60	no	yes
XXS H <sub>2</sub> S LC [ppm]	0 to 100	5	yes	no	10	no	yes
XXS NO <sub>2</sub> [ppm]	0 to 50	5	yes	no	10	no	yes
XXS SO <sub>2</sub> [ppm]	0 to 100	1	yes	no	2	no	yes

1) Different settings can be selected to meet customer requirements on delivery. The current setting can be checked and changed with the Dräger CC Vision software.

A version of the CC-Vision software that can be used for Dräger X-am 2500 is available for download from the product page for the X-am 2500 at the following web address: [www.draeger.com](http://www.draeger.com)

2) With O<sub>2</sub>, A1 is the lower alarm threshold: an alarm is triggered if the value is too low.

### 3.3.2 Standard instrument configuration

Dräger X-am <sup>®</sup> 2500 <sup>1</sup>	
Bump test mode <sup>2</sup>	Extended bump test
Fresh-gas adjustment <sup>2)</sup>	ON
Operating signal <sup>2)</sup> <sup>3</sup>	ON
Switch off <sup>2)</sup>	allowed
LEL factor <sup>2)</sup> (ch <sub>4</sub> )	4.4 (vol. %) (4.4 vol. % corresponds to 100 %LEL)
STEL <sup>2)</sup> <sup>4</sup> <sup>5</sup> (short-term average)	STEL function - disabled Average value duration = 15 minutes
TWA <sup>2)</sup> <sup>5)</sup> <sup>6</sup> (shift average)	TWA function - disabled Average value duration = 8 hours
Alarm A1 <sup>7</sup>	can be acknowledged, non-latching, pre-alarm, rising flank
Alarm A1 at O <sub>2</sub> sensor	cannot be acknowledged, latching, like main alarm, falling flank
Alarm A2 <sup>7)</sup>	cannot be acknowledged, latching, main alarm, rising flank

- 1) X-am<sup>®</sup> is a registered trademark of Dräger.
- 2) Different settings can be selected to meet customer requirements on delivery. The current setting can be checked and changed with the Dräger CC Vision software.
- 3) A periodic short signal indicates the operating capacity of the instrument. If there is no operating signal, correct operation cannot be guaranteed.
- 4) STEL: average value of an exposure over a short period, generally 15 minutes.
- 5) Interpretation only if the sensor is designed for this.
- 6) TWA: shift averages are workplace limit values for generally eight hours per day of exposure for five days a week during a working life.
- 7) Latching and acknowledgement of alarms A1 and A2 can be configured with the Dräger CC Vision PC software.

Changing the configuration: see "Replacing the sensors" on page 21.



#### WARNING

After a basic initialisation has been carried out with the PC software Dräger CC Vision, individual alarm settings may have been changed.

### 3.3.3 Configuring the device

To individually configure a standard-configuration device, connect the device to a PC. The installed PC software Dräger CC Vision is used for configuration.

A version of Dräger CC-Vision suitable for the Dräger X-am 2500 can be downloaded on the product page of the X-am 2500: [www.draeger.com](http://www.draeger.com).

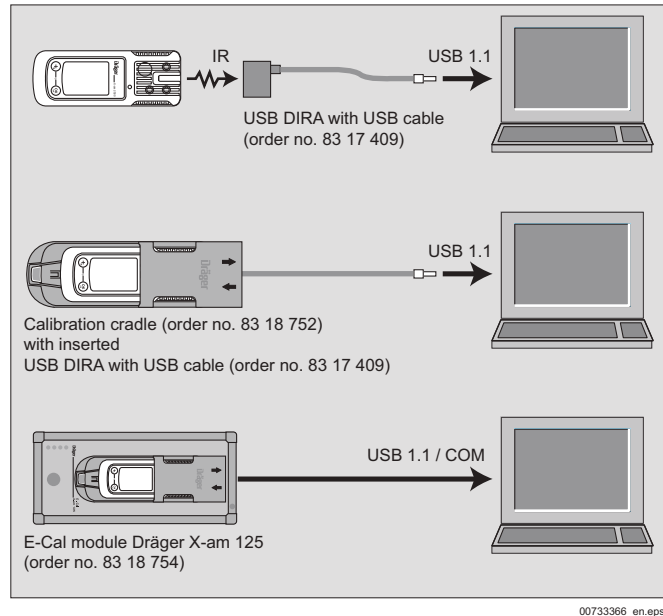

- Observe the documentation and online help of the software.
- A version of the CC-Vision software that can be used for Dräger X-am 2500 is available for download from the product page for the X-am 2500 at the following web address: [www.draeger.com](http://www.draeger.com)

#### Device settings

The following changes can be made to the device parameters for a device:

Designation	Field
Password	Numeric field (3-figure)
Operating signal LED <sup>1</sup>	Yes/No
Operating signal horn <sup>1)</sup>	Yes/No
Switch-off mode	"Switch off permitted" or "Switch off prohibited" or "Switch off prohibited at A2"
Shift length (TWA) <sup>2</sup> (in minutes)	60 - 14400 (setting for exposure alarm)
Short-term exposure limit (STEL) <sup>3</sup> <sup>4</sup> (in minutes)	0 - 15 (setting for exposure alarm)
User ID(12 characters)	Alphanumeric field
Switch database on or off	On/Off
Overwrite database	Yes/No
Database mode	Peak/Average
Database interval	1 s / 10 s / 30 s / 1 min / 2 min / 5 min / 10 min / 30 min
Date	(date on the PC)
Time	(time on the PC)
Warning after expiry of calibration interval	Yes/No
Error after expiry of calibration interval	Yes/No
Delay until error after expiry of calibration interval (days)	0 - 10
Automatic detection of Bump Test Station	Yes/No

Activate sensitivity calibration following negative bump test	Yes/No (relates only to a device connected to the Dräger Bump Test Station)
Bump test mode	“extended bump test” or “quick bump test” or “bump test deactivated”
Warning after expiry of bump test interval	Yes/No
Error after expiry of bump test interval (if warning activated)	Yes/No
Bump test interval (days)	1 - 732
Delay until error after expiry of cal. interval (days)	0 - 10
Activate user service life	Yes/No
User service life (days) (if activated)	0 - 999
Running in	Yes/No
LEL category	“---” or “PTB” or “IEC” or “NIOSH” (if this is changed, the LEL factor will be altered to match)

- At least one of the two operating signals must be switched on.
- Corresponds to the averaging time and is used to calculate the exposure value TWA.
- Only evaluated if the sensor is provided for the purpose.
- Corresponds to the averaging time and is used to calculate the exposure value STEL.

### Sensor settings

The following changes can be made to the sensor parameters for the sensors:

Designation	Field
Alarm threshold A1 (in measurement unit)	0 - A2
Alarm threshold A2 (in measurement unit)	A1 – Measuring range limit value
Type of evaluation <sup>1</sup>	Inactive, TWA, STEL, TWA+STEL
Alarm threshold STEL (in measurement unit) <sup>1</sup>	0 – Measuring range limit value
Alarm threshold TWA (in measurement unit) <sup>1</sup>	0 – Measuring range limit value
Calibration interval (days)	0 - 180 (sensor-dependent)
Unit (sensor-dependent)	Vol%, %UEG, %LEL, %LIE, ppm, mbar, ppb, mg/m <sup>3</sup>
Gas name: “Ex” (CatEx sensor only)	Yes/No

- Only evaluated if the sensor is provided for the purpose.

### Testing the parameters

In order to ensure that the values have been correctly transferred to the gas measuring device:

- Press the touch button **Data from X-am 1/2/5x00**
- Check parameters.

### 3.3.4 Export data memory and display graphically

To read the database of the instrument and display it graphically, the instrument must be connected with a PC.

The installed Dräger GasVision PC software is used for exporting and displaying the database.

- Observe the documentation and online help of the software.

## 3.4 Running the bump test

### 3.4.1 Manual implementation without documentation of the results in the instrument memory

- Prepare a test gas cylinder, the volume flow must be 0.5 l/min and the gas concentration must be higher than the alarm threshold concentration that is to be tested.  
Example test gas cylinder 68 11 130 = mixed gas with 50 ppm CO, 15 ppm H<sub>2</sub>S, 2.5 vol. % CH<sub>4</sub>, 18 vol. % O<sub>2</sub>
- Connect the test gas cylinder with the calibration cradle (order no. 83 18 752).
- Vent the test gas into a fume cupboard or into the open air (with a hose connected to the second connector of the calibration cradle).

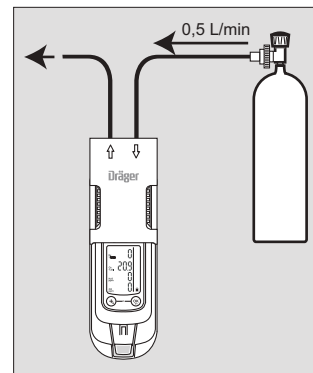

0083396.eps



### CAUTION

Never inhale the test gas. Health hazard! Observe the hazard warnings of the relevant Safety Data Sheets.

- Switch on the instrument and insert it into the calibration cradle – press downwards until it engages.
- Open the test gas cylinder valve to let test gas flow over the sensors.  
Recommendation: Wait until the instrument displays the test gas concentration with sufficient tolerance –  
Ex: ±20 % of the test gas concentration<sup>1</sup>  
O<sub>2</sub>: ±0.6 vol. %<sup>1</sup>  
TOX: ±20 % of the test gas concentration<sup>1</sup>  
Wait until at least alarm threshold A1 or A2 has been exceeded, however.  
If the alarm thresholds are exceeded, the instrument displays the gas concentration in alternation with » **A1** « or » **A2** « depending on the test gas concentration.
- Close the test gas cylinder valve and remove the instrument from the calibration cradle.

If the concentration has now fallen under the A1 alarm threshold:

- Acknowledge the alarm.

If the displays are outside of the above-mentioned ranges:

- Calibrating/adjusting the instrument, see section 5 on page 18.

<sup>1</sup> Upon application of the Dräger mixed gas (order no. 68 11 130) the displays should be within this range.

### 3.4.2 Menu implementation with the documentation of results in the instrument memory

The setting to "Quick bump test" or "Extended bump test" is made using the PC software Dräger CC Vision.

In the "Quick bump test" a check is carried out as to whether or not the gas concentration has exceeded alarm threshold 1 (with oxygen, the test checks that alarm threshold 1 has not been reached).

In the case of the "Extended bump test", a check is made as to whether the gas concentration has reached the set bump test concentration within a tolerance window.

Setting on delivery: Extended bump test.

1. Prepare a test gas cylinder, the volume flow must be 0.5 l/min and the gas concentration must be higher than the alarm threshold concentration that is to be tested.  
Example test gas cylinder 68 11 130 = mixed gas with 50 ppm CO, 15 ppm H<sub>2</sub>S, 2.5 vol. % CH<sub>4</sub>, 18 vol. % O<sub>2</sub>
2. Connect the test gas cylinder with the calibration cradle (order no. 83 18 752).
3. Vent the test gas into a fume cupboard or into the open air (with a hose connected to the second connector of the calibration cradle).

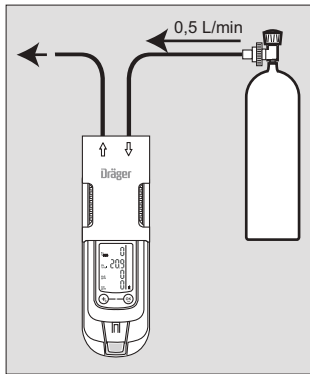

00833366.eps

#### Ending the bump test:

After the set bump test concentration has been reached or a gas alarm has been triggered (with "Quick bump test"):

- The display containing the current gas concentration changes with the display » OK «.
  - The bump test that was carried out is documented with the result and date in the instrument memory.
8. Close the test gas cylinder valve and remove the instrument from the calibration cradle.
  - If the concentration values have now fallen under the A1 alarm thresholds, the instrument returns to the measuring mode.
  - If the set bump test concentration is not reached within the set time, an error is issued.
    - The fault message » ✘ « appears and » - - « is displayed instead of the measured value on the faulty measuring channel.
    - In this case, repeat the bump test or calibrate the instrument, page 21.

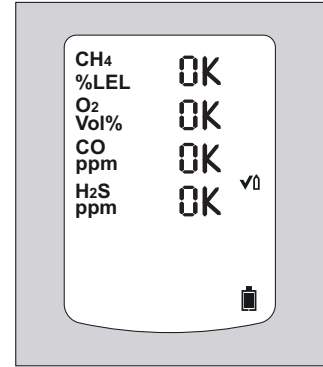

01033366\_en.eps

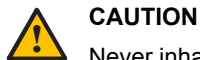

#### CAUTION

Never inhale the test gas. Health hazard! Observe the hazard warnings of the relevant Safety Data Sheets.

4. Switch on the instrument and insert it into the calibration cradle – press downwards until it engages.
5. Open the Quick menu and select the bump test, page 17.  
The current gas concentration values and the special symbol » √ « (for bump test) flash.
6. Press the (OK) key to start the bump test.
7. Open the test gas cylinder valve to let test gas flow over the sensor.
- If gas concentration exceeds the alarm thresholds A 1 or A 2 the corresponding alarm will occur.

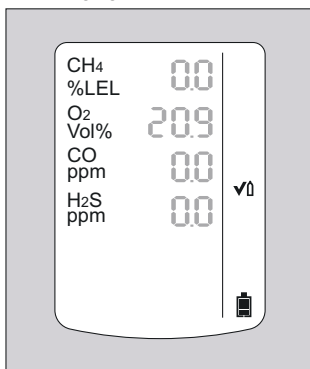

00933366\_en.eps

The bump test can also be run automatically. The "Bump Test Station" is required for this function, see section 3.4.3 on page 14.

### 3.4.3 Automatic implementation with the Bump Test Station

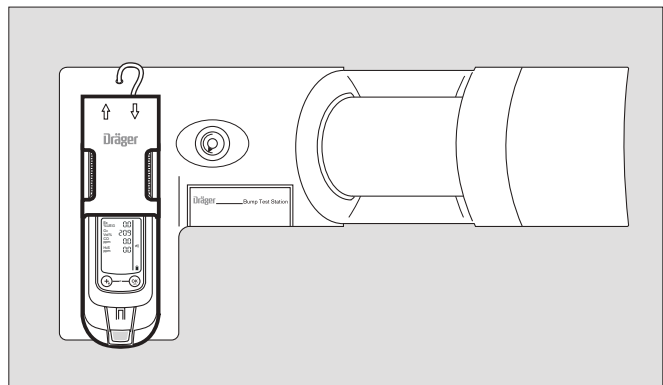

01333366.eps

#### Prerequisite:

The instrument first needs to be configured for the automatic bump test using the Dräger CC-Vision PC software.

- Activating the instrument for the automatic bump test.
- Composition of test gas (mixed gas) – standard on delivery: 50 ppm CO, 15 ppm H<sub>2</sub>S, 2.5 vol. % CH<sub>4</sub>, 18 vol. % O<sub>2</sub>

- Define which measuring channels should participate in the automatic bump test. All measuring channels participate in the bump test by default.

- Prepare the Bump Test Station according to the instructions.
- Switch on the instrument and insert it into the receptacle of the Bump Test Station until it engages. The bump test will be started automatically. The special symbol » √ « (for bump test) flashes.

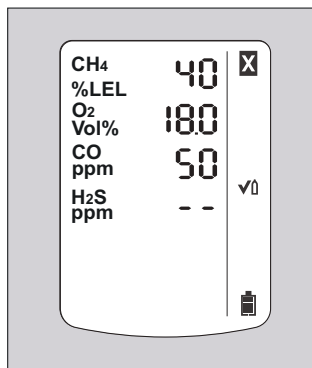

01133366\_en.eps

If a gas alarm (quick bump test) is initiated and the set bump test concentration (Accelerated bump test) is reached within the set time, the current gas concentration will be displayed alternately with » OK «.

- Remove the instrument from the Bump Test Station.
  - If the concentration values have now fallen under the A1 alarm thresholds, the instrument returns to the measuring mode.
  - If there is no alarm during the bump test and the current measurements do not reach the set target concentration ("Accelerated bump test" only), an error is issued.
    - The fault message » X « appears and » -- « is displayed instead of the measured value on the faulty measuring channel.
    - In this case, repeat the bump test or calibrate the instrument, page 21.

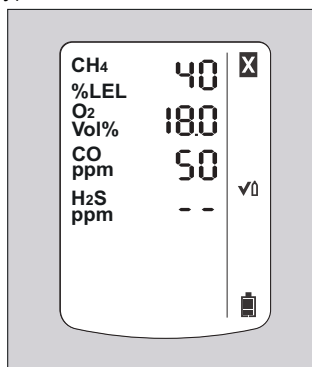

01133366\_en.eps

The bump test can also be run manually, see section 3.4.1 on page 13.

The Dräger CC Vision PC software can be used to enable the "Automatic calibration after incorrect bump test" option.

### 3.5 During operation

- During operation, the measured values for every measured gas are displayed.
- If a measuring range is exceeded or not reached, the following displays are shown instead of the measured value display:

- » r r « (measuring range exceeded) or
- » L L « (measuring range not reached) or
- » r J « (blocking alarm).

- Excess concentrations of flammable materials can lead to a lack of oxygen.
- For O<sub>2</sub> concentrations under 8 vol. % an error is indicated with » -- « at the ex-channel instead of the measuring value as long as the measuring value falls below the pre-warning threshold.
- In the event of an alarm, the corresponding displays, including the visual, audible and vibration alarms, are activated, see section 6 on page 21.

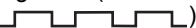

#### NOTICE

Special states in which there is no measuring operation (quick menu, calibration menu, warm-up of sensors, password input) are indicated by a visual signal (slow flashing of the alarm LED .

If the measuring range is exceeded significantly at the CatEx channel (very high concentration of flammable materials), a blocking alarm is triggered. This CatEx blocking alarm can be acknowledged manually by switching the instrument off and back on again in fresh air.



#### WARNING

In the event of an impact load when using a CatEx sensor in the Dräger X-am 2500 that causes the fresh air display to deviate from zero, the zero point and sensitivity must be adjusted.

After the measuring range of the TOX measuring channels has been exceeded temporarily (up to one hour), checking the measuring channels is not necessary.

### 3.6 Identifying alarms

An alarm is displayed visually, audibly and through vibration in a specific pattern.

#### 3.6.1 Concentration pre-alarm A1

Intermittent alarm: 

Display » A1 « and measured value alternating:

The pre-alarm A1 is not latching and stops when the concentration has dropped below the alarm threshold A1.

- In case of A1, a single tone is audible and the alarm LED flashes.

#### Acknowledging the pre-alarm:

- Press the (OK) key. Only the audible alarm and the vibration alarm are switched off.

### 3.6.2 Concentration main alarm A2



#### WARNING

Risk of fatal injury! Leave the area immediately. A main alarm is self-latching and cannot be acknowledged or cancelled.

Intermittent alarm:



Display » **A2 and measured value** alternating:

- In case of A2, a double tone is audible and the alarm LED flashes twice.

After leaving the area, when the concentration has dropped below the alarm threshold:

- Press the key. The alarm messages are switched off.

If the measuring range is exceeded significantly on the CatEx channel (very high concentration of flammable materials), a blocking alarm is triggered. This CatEx blocking alarm can be acknowledged manually by switching the instrument off and back on again in fresh air.

### 3.6.3 STEL / TWA exposure alarm



#### WARNING

Leave the area immediately. After this alarm, the deployment of personnel is subject to the relevant national regulations.

Intermittent alarm:



Display » **A2** « and » « (STEL) or » « (TWA) and measured value alternating:

- The STEL and TWA alarm cannot be acknowledged or cancelled.
- Switch off the instrument. The values for the exposure evaluation are deleted after the instrument is switched on again.

### 3.6.4 Battery pre-alarm

Intermittent alarm:



Flashing special symbol » « on the right side of the display:

#### Acknowledging the pre-alarm:

- Press the key. Only the audible alarm and the vibration alarm are switched off.
- The battery still lasts min. 20 minutes after the first battery pre-alarm.

### 3.6.5 Battery main alarm

Intermittent alarm:



Flashing special symbol » « on the right side of the display:

The battery main alarm cannot be acknowledged or cancelled:

- The device automatically switches off after 10 seconds.
- Before the instrument is switched off, the visual, audible and vibration alarms are activated for a short time.

### 3.6.6 Instrument alarm

Intermittent alarm:



Special symbol » « displayed on the right side of the display:

- The instrument is not ready for operation.
- For corrective measures, see "Replacing the sensors" on page 21 to page 24.
- Contact maintenance or Draeger Service to rectify the problem.



## 4 Menu functions

### 4.1 Activating the Info mode

- In measuring mode, press the **OK** key for approx. 3 seconds.
- If any warning or fault messages exist, the corresponding information or error codes will be displayed (see section 8 on page 22).
- Press the **OK** key successively for the next display.
- The peak values and the exposition values TWA<sup>1</sup> and STEL<sup>1)</sup> are displayed.

**I** Warning messages are displayed. Numerical codes of warning messages: see section 8.1 on page 22.

**OK** key

**X** Fault messages are displayed. Numerical codes of fault messages: see section 8.2 on page 24.

**OK** key

**▲** The peak values = the maximum measured values in the case of, e.g., CO, H<sub>2</sub>S, ... or the minimum measured values in the case of O<sub>2</sub> within the storage interval are displayed

**OK** key

**8** The average values of the exposures based on a shift of, e.g., 8 hours (TWA) of all the active sensors for the exposure evaluation are displayed

**OK** key

**⌚** The short-term values (STEL) = average values of the concentrations over the average value duration of all the active sensors for the exposure evaluation are displayed

**OK** key

The instrument is in measuring mode again

- If no key is pressed for 10 seconds, the instrument returns automatically to measuring mode.

### 4.2 Opening Info-Off Mode

- When the instrument is in a deactivated state, press the **+** key.  
The name of the gas, measuring unit, and measuring range limit value are displayed for all channels.
- Pressing the **OK** key again exits the Info Off mode (or via timeout).

### 4.3 Quick Menu

#### 4.3.1 Quick menu functions

- ✓** Bump test see section 3.4 on page 13
- \*** Fresh air calibration, see section 5.2 on page 18
- ▲** Delete peak values, see section 4.3.3 on page 17

#### 4.3.2 Opening the Quick Menu

On delivery, only the fresh air calibration is activated in the Quick Menu. The PC software Dräger CC Vision can be used

to activate the bump test for the quick menu and/or the function for displaying and deleting peak values.

1. In measuring mode, press the **+** key three times.  
If no functions have been activated in the quick menu, the instrument remains in measuring mode.
2. You can select the activated functions of the quick menu by pressing the **+** key.
  - Press the **OK** key to call the selected function.
  - Press the **+** key to cancel the active function and to switch to measuring mode.
  - If no key is pressed for 60 seconds, the instrument returns automatically to measuring mode.

#### 4.3.3 Quick menu "Delete peak values"

After the function has been selected, the current peak values are displayed; the peak values special symbol appears in the display at the same time.

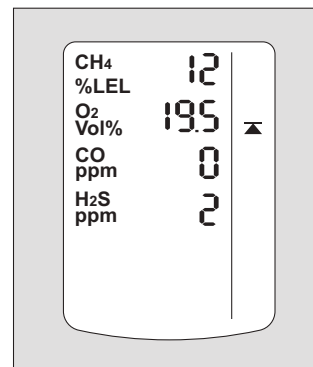

00433366\_en.eps

1. The peak values can be deleted by pressing the **OK** key for 5 sec. and the adjacent display appears, for example.
2. Press the **OK** key to end the function.

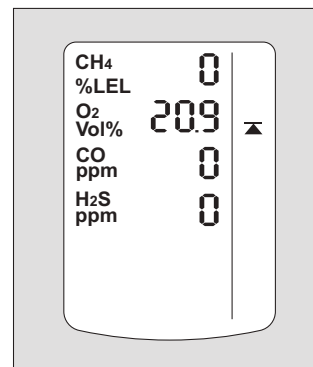

00533366\_en.eps

### 4.4 Calibration Menu

#### 4.4.1 Calibration menu functions

- \*** Fresh air calibration, see section 5.2 on page 18
- 1** 1-button calibration, see section 5.3 on page 19
- ⌚** Single gas calibration, see section 5.3.1 on page 19

#### 4.4.2 Open the Calibration Menu

- The calibration menu can only be accessed by entering a password.  
Password on delivery: » 001 «
- The default password on delivery can be changed using the PC software Dräger CCVision.

<sup>1</sup> Only when activated in the instrument configuration. Delivery status: not activated.

1. In measuring mode, press the **+** key for at least 4 seconds. The function for entering the password is selected. The special symbol » **🔒** « (for the "enter password" function) is displayed.  
The display shows » **000** «, with the first digit flashing.
2. Use the **+** key to set the flashing digit.
3. Press the **OK** key, the second digit starts flashing.
4. Use the **+** key to set the flashing digit.
5. Press the **OK** key, the third digit starts flashing.
6. Use the **+** key to set the flashing digit.
7. Press the **OK** key to confirm the password once it has been set completely.
8. The calibration menu functions can now be selected by pressing the **+** key.
  - o Press the **OK** key to call the selected function.
  - o Press the **+** key to cancel the active function.
  - o If no key is pressed for 10 minutes, the instrument automatically returns to measuring mode.

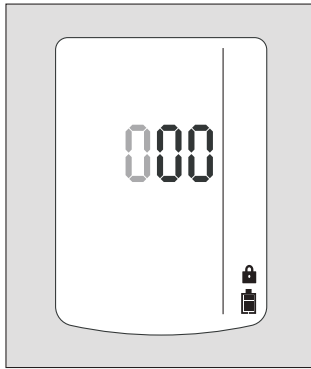

00633366.eps

## 5 Calibrate instrument

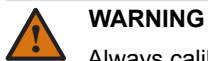

### WARNING

Always calibrate the zero-point before span. Otherwise, the calibration will contain errors!

- Adjustment may not be possible due to instrument and channel errors.
- Allow the sensors to warm up before the calibration!
- Warming-up time: see instructions for use / data sheets for the Dräger sensors installed (product page for X-am 2500 at [www.draeger.com](http://www.draeger.com)).

### 5.1 Adjustment interval:

- Observe the relevant specifications in the Instructions for Use/data sheets of the Dräger Sensors installed.
- For critical applications, observe the recommendations in EN 60079-29-2<sup>1</sup> or EN 45544-4<sup>2</sup> and national regulations. We recommend that you adjust all the channels after 6 months.

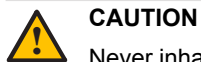

### CAUTION

Never inhale the test gas. Health hazard! Observe the hazard warnings of the relevant Safety Data Sheets.

- 1 EN60079-29-2 – Guidelines for selection, installation, use and maintenance of instruments for the detection and measurement of flammable gases and oxygen.
- 2 EN 45544-4 – Electrical instruments for the direct detection and direct concentration measurement of toxic gases and vapours – Part 4: Guide for selection, installation, use and maintenance.

- Improving the zero point accuracy – perform fresh air calibration, page 18.
- Set the sensitivity of all sensors to the value of the test gas – carry out the 1-button calibration, page 19.
- Set the sensitivity of a sensor to the value of the test gas – span calibration/adjustment, page 19.

### 5.2 Run fresh air calibration

To improve the zero-point accuracy, a fresh air calibration can be carried out.

- Calibrate the instrument to fresh air, free of measured gases or other interfering gases.
  - Sensors which have not warmed up or which are faulty prevent a calibration.
    - o In the case of sensors which are in the warm-up phase, the message » **159** « is displayed with the special symbol » **🔒** « (for warning message).
    - o In the case of a sensor or instrument error, the message » **109** « is displayed with the special symbol » **🔒** « (for a fault message).
    - o The message is cleared after 5 seconds and the function is available again in the menu.
  - During the fresh air calibration the zero point of all sensors (with the exception of the DrägerSensor XXS O<sub>2</sub>) are set to 0.
  - In the case of the DrägerSensor XXS O<sub>2</sub>, the display is set to 20.9 vol. %.
1. Switch on instrument.
  2. Depending on instrument configuration:
    - o Open the Quick menu and select the fresh air calibration function, page 17.
    - or
    - o Open the Calibration menu and select the fresh air calibration function, page 17.
  - The current gas concentration values flash.
  - When the measured values have stabilized:
  3. Press the **OK** key to carry out the fresh air calibration.

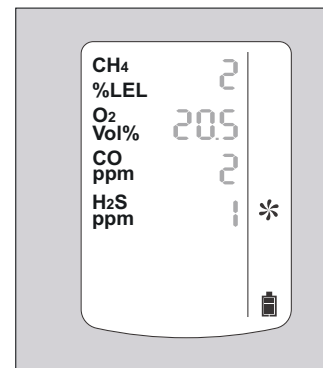

01333366\_en.eps

- The display containing the current gas concentration changes with the display » **OK** «.
- 4. Press the **OK** key to confirm the calibration or wait for approx. 5 seconds.

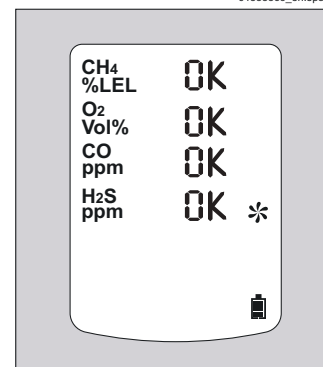

01433366\_en.eps

If a fault has occurred during the fresh air calibration:

- The fault message »  « appears and » - - « is displayed for the respective sensor instead of the measured value.
- In this case, repeat the fresh air calibration.
- Replace the sensor if necessary, page 21.

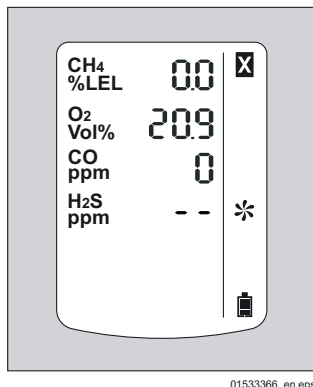

### 5.3 1-button calibration



#### NOTICE

If no sensors have been approved by the Dräger CC-Vision PC program for the 1 button calibration, the 1-button calibration will not be available.

- All sensors approved by the Dräger CC-Vision PC program are included in the 1-button calibration.
- In the case of the 1-button calibration, the sensitivity of all sensors is set to the value of the test gas.  
When using test gas cylinder 68 11 130 = mixed gas with 50 ppm CO, 15 ppm H<sub>2</sub>S, 2.5 vol. % CH<sub>4</sub>, 18 vol. % O<sub>2</sub>.

- If a mixed gas with another composition is used, the specified concentration values in the instrument must be changed to the target values of the mixed gas used using the PC software "Dräger CC-Vision".

1. Connect the test gas cylinder with the calibration cradle.
2. Vent the test gas into a fume cupboard or into the open air (with a hose connected to the second connector of the calibration cradle).

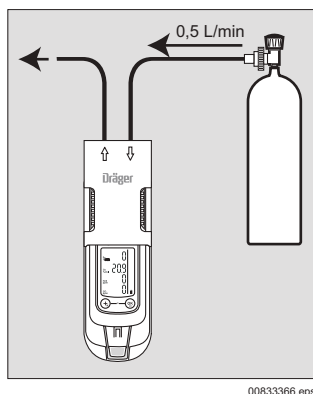

#### CAUTION

Never inhale the test gas. Health hazard! Observe the hazard warnings of the relevant Safety Data Sheets.

3. Switch on the instrument and insert it into the calibration cradle until it engages.
4. Call the calibration menu, enter the password and select the 1-button calibration function, page 17.
5. Press the  key to start the 1-button calibration.
6. Open the test gas cylinder valve to let test gas flow over the sensor.

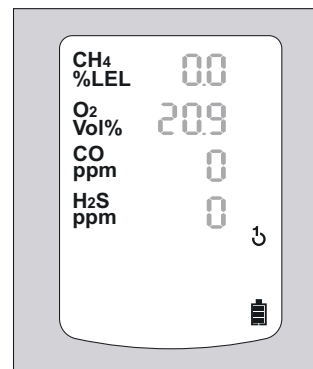



The currently displayed measured values start to flash.

The flashing stops after a static measured value has been reached.

The calibration is now carried out automatically.

The displayed measured values change to the values according to the gas supplied.

7. The automatic stability monitoring can be overridden by pressing the  key. A calibration is carried out immediately. If it is detected that no test gas has been supplied, the 1-button calibration is cancelled. The channels then display » n/a «. If only one sensor is included in the 1-button calibration, an adjustment is carried out in any case when the  key is pressed.

When the calibration is completed and the displayed measured values have stabilised:

- The display containing the current gas concentration changes with the display » OK «.
- 8. Press the  key or wait for 5 seconds to quit the calibration.
- The instrument changes to the measuring mode
- 9. Close the test gas cylinder valve and remove the instrument from the calibration cradle.

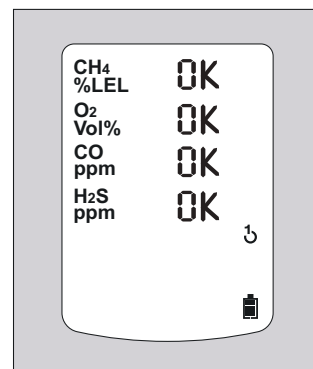

If a fault occurs during the 1-button calibration:

- The fault message »  « appears and » - - « is displayed for the respective sensor instead of the measured value.
- In this case, repeat the 1-button calibration or carry out a single gas calibration, see section 5.3.1 on page 19.
- Replace the sensor if necessary, page 21.

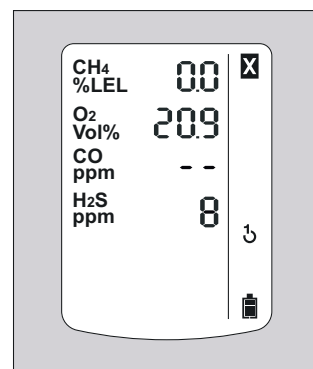

#### 5.3.1 Calibrating the sensitivity for an individual measuring channel

- The span calibration can be carried out specifically for individual sensors.

- In the case of the span calibration, the sensitivity of the selected sensor is set to the value of the test gas used.

- Use a standard test gas. Allowed test gas concentration:

Ex: 40 to 100 %LEL

O<sub>2</sub> 10 to 25 vol. %

CO: 20 to 999 ppm

H<sub>2</sub>S: 5 to 99 ppm

Test gas concentration of other gases: see Instructions for Use for the respective DrägerSensors.

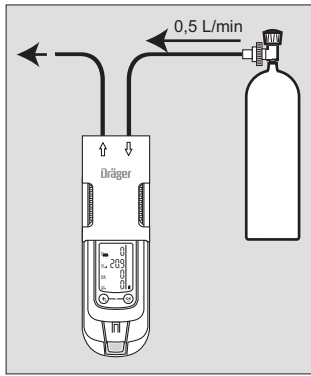

00833366.eps

1. Connect the test gas cylinder with the calibration cradle.
2. Vent the test gas into a fume cupboard or into the open air (with a hose connected to the second connector of the calibration cradle).

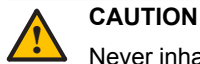

**CAUTION**

Never inhale the test gas. Health hazard! Observe the hazard warnings of the relevant Safety Data Sheets.

3. Switch on the instrument and insert it into the calibration cradle.
4. Press the [ + ] key and keep it pressed for 5 seconds to open the calibration menu, enter the password and select the single gas calibration function, page 17.
5. Press the OK key to start the channel selection.

- The display flashes the gas of the first measuring channel, e.g. » Ex %LEL «.
- 6. Press the OK key to start the calibration function of this measuring channel, or use the ⊕ key to select another measuring channel (O<sub>2</sub> - vol. %, H<sub>2</sub>S - ppm or CO - ppm).

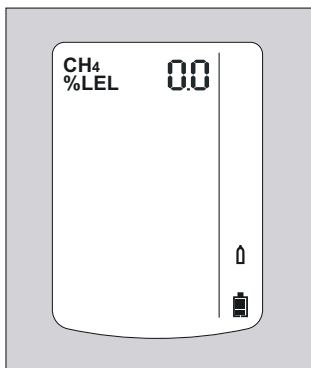

01933366\_en.eps

**5.3.2 Sensitivity calibration for CatEx**

Display on channel selection:

1. Press the OK key to start the calibration for the heat tinting or press the ⊕-key to select the next sensor.

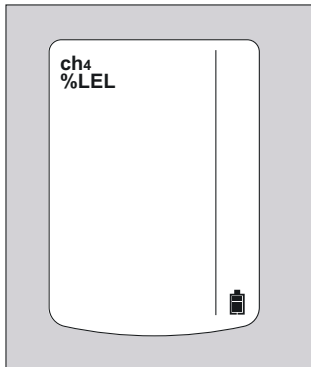

02033366.eps

If the displayed measurement value is stable:

2. Press the OK key to perform the calibration.

The display containing the current gas concentration changes with the display » OK «.

3. Press the OK key or wait for approx. 5 seconds to end the calibration of this measuring channel.

The next measuring channel is offered for calibration.

After the calibration of the last measuring channel, the device changes to measuring mode.

4. Close the test gas cylinder valve and remove the device from the calibration cradle.



02433366\_en.eps

If a fault occurred during the span calibration.

- The fault message » ✖ « appears and » - - « is displayed for the sensor instead of the measured value.
- In this case, repeat the calibration.
- If necessary, replace the sensor, page 21.

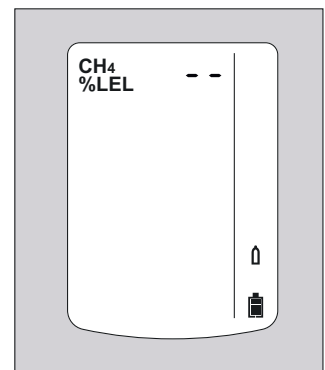

02533366\_en.eps

5. Press the OK key to confirm the calibration gas concentration or use the [ + ] key to change the calibration gas concentration and complete the process by pressing the OK key. The measurement value flashes.
6. Open the test gas cylinder valve to let test gas flow over the sensor. The displayed, flashing measurement value changes to the value according to the supplied test gas.
7. Press the ⊕-key to select the next sensor.

### Notice for the adjustment of the ex-channel to nonane as a measuring gas:

- During the calibration of the ex-channel, propane can be used as a substitute calibration gas.
- When using propane to adjust the ex-channel to nonane, the display must be set to twice the used test gas concentration.

### Notice for the use in subsurface mining:

- For the calibration of the ex-channel to the measuring gas methane, the display of the instrument must be set to a value of 5 % (relative) higher than the used test gas concentration.

## 6 Operation with pump

### With Dräger Pump X-am 1/2/5000

#### Accessories:

Dräger Pump X-am 1/2/5000, sampling hose and probes, see section 13 on page 31.

#### Commissioning and performing the measurement:

- Refer to the Instructions for Use of the Dräger Pump X-am 1/2/5000.

### With manual pump adapter and rubber ball pump

#### Accessories:

For manual pump adapter, rubber ball pump, sampling hose and probes, see section 13 on page 31.

#### Commissioning and performing the measurement:

- Refer to the Instructions for Use of the accessories used.

### Observe the following during measuring mode with pump

- Wait for the flushing time to elapse:  
Before every measurement, flush the Dräger sampling hose or the Dräger probes with the air sample to be measured.
- A flushing phase is necessary to eliminate or minimise all effects associated with the use of a sampling hose or a probe, e.g. memory effects, dead volume.
- The duration of the flushing phase depends on factors such as type and concentration of the gas or vapour to be measured, material, length, diameter, and age of the sampling hose or probe. Generally, when using a sampling hose (new, dry, clean), a typical flushing time of approx. 3 seconds is required for each metre. This flushing time applies in addition to the sensor response time (see the Instructions for Use for the gas detection instrument used).

#### Example:

In the case of a sampling hose with a length of 10 m, the flushing time is approx. 30 seconds and the sensor response time is in addition approx. 60 seconds. Therefore, the total time before reading the gas measuring instrument is approx. 90 seconds.

The flow-rate alarm is delayed by 10 to 30 seconds depending on the length of the hose.

## 7 Replacing the sensors

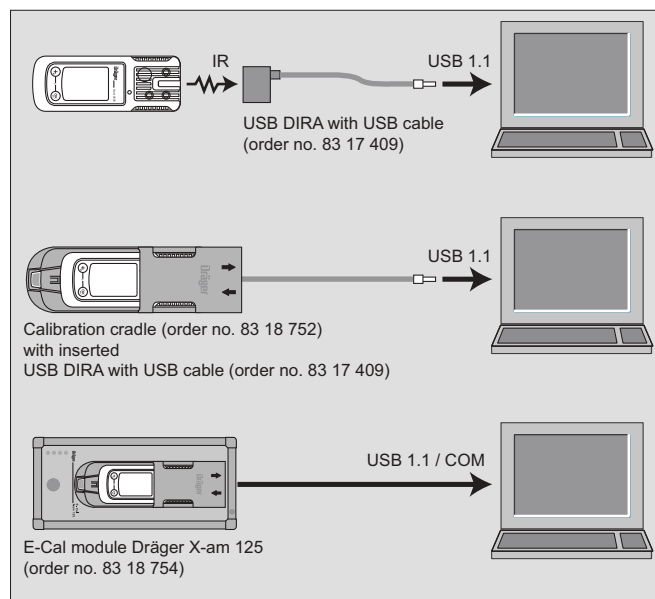

0073396\_en.eps

- To replace the sensors of the instrument, connect the instrument with a PC.
- Replace the sensors using the PC program Dräger CC Vision.

#### Next:

- Conduct the fresh air calibration page 18.

#### and then:

- Calibrating sensitivity:  
either  
perform 1-button calibration, page 19  
or  
run sensitivity calibration, see page 19.

## 8 Troubleshooting

Fault	Cause	Remedy
Not possible to switch on the instrument	Discharged power pack	Charge the power pack, page 8.
	Discharged alkaline batteries	Insert new alkaline batteries, page 21.
Not possible to switch off the instrument	The instrument is not set to measuring mode	Select measuring mode.
	The instrument is configured to "Disable prohibited"	Configure the instrument to "Disable allowed" with Dräger CC Vision.
Display » -- «	Measuring range calibrated/adjusted incorrectly	Recalibrate/adjust the measuring range, page 21.
	Electronics or sensors defective	Must be repaired by Service.

List of the numerical codes of the warning and fault messages in the info mode, see page 17.

### 8.1 Warning messages

Special symbol » ⓘ « and displayed numerical code:	Cause	Remedy
152	Customer's service life counter about to elapse	Reset the service life counter using Dräger CC Vision.
153	Database 90 % full	Read the database soon and clear memory afterwards.
154	Database full	Read the database and clear memory.
155	Interval for bump test elapsed	Conduct the bump test page 21.
159	Calibration not possible. The menu function cannot be carried out because of a message which is preventing the function (e.g. sensors in warm-up phase).	Determine the message code via the info menu and switch it off, if necessary.
251	DrägerSensor CatEx 125 PR warming up	Wait until warm-up time is complete.
252	DrägerSensor CatEx 125 PR warming up	Wait until warm-up time is complete.
253	Ex concentration has drifted into the negative range	Conduct the fresh air calibration page 18.
254	The temperature is too high	Operate the instrument within the allowed temperature range.
255	The temperature is too low	Operate the instrument within the allowed temperature range.
256	Calibration interval for DrägerSensor CatEx 125 PR has expired	Perform sensitivity calibration for DrägerSensor CatEx 125 PR, page 19.
257	Alarm threshold A2 is set to greater than 60 %LEL	Set alarm threshold to less than 60 %LEL.
271	Heat conductance calibration interval for DrägerSensor CatEx 125 PR has expired	Perform sensitivity calibration for DrägerSensor CatEx 125 PR, page 19.
272	Sensor is switched off due to excess gas	Restart the device
351	DrägerSensor XXS EC1 is warming up	Wait until warm-up time is complete.
352	DrägerSensor XXS EC1 is warming up	Wait until warm-up time is complete.
353	EC1 concentration has drifted into the negative range	Conduct the fresh air calibration page 18.
354	The temperature is too high	Operate the instrument within the allowed temperature range.

<b>Special symbol » ⓘ « and displayed numerical code:</b>	<b>Cause</b>	<b>Remedy</b>
<b>355</b>	The temperature is too low	Operate the instrument within the allowed temperature range.
<b>356</b>	The calibration interval for DrägerSensor XXS EC1 has elapsed	Run sensitivity calibration for DrägerSensor XXS EC1, page 19.
<b>357</b>	Alarm threshold A2 is set to greater than 60 %LEL	Set alarm threshold to less than 60 %LEL.
<b>451</b>	DrägerSensor XXS EC2 in the warm-up phase	Wait until warm-up time is complete.
<b>452</b>	DrägerSensor XXS EC2 in the warm-up phase	Wait until warm-up time is complete.
<b>453</b>	EC2 concentration has drifted into the negative range	Conduct the fresh air calibration page 18.
<b>454</b>	The temperature is too high	Operate the instrument within the allowed temperature range.
<b>455</b>	The temperature is too low	Operate the instrument within the allowed temperature range.
<b>456</b>	The calibration interval for DrägerSensor XXS EC2 has elapsed	Run sensitivity calibration for DrägerSensor XXS EC 3, page 19.
<b>457</b>	Alarm threshold A2 is set to greater than 60 %LEL	Set alarm threshold to less than 60 %LEL.
<b>551</b>	DrägerSensor XXS EC3 in the warm-up phase	Wait until warm-up time is complete.
<b>552</b>	DrägerSensor XXS EC3 in the warm-up phase	Wait until warm-up time is complete.
<b>553</b>	EC3 concentration has drifted into the negative range	Conduct the fresh air calibration page 18.
<b>554</b>	The temperature is too high	Operate the instrument within the allowed temperature range.
<b>555</b>	The temperature is too low	Operate the instrument within the allowed temperature range.
<b>556</b>	The calibration interval for DrägerSensor XXS EC3 has elapsed	Run sensitivity calibration for DrägerSensor XXS EC 3, page 19.
<b>557</b>	Alarm threshold A2 is set to greater than 60 %LEL	Set alarm threshold to less than 60 %LEL.
<b>575</b>	Calibration interval for the compensation channel has elapsed	Adjust the sensitivity of the compensation channel.
<b>576</b>	Calibration required because of overgassing.	Adjust the sensitivity of the compensation channel.
<b>651</b>	DrägerSensor XXS EC 4 in the warm-up phase	Wait until warm-up time is complete.
<b>652</b>	DrägerSensor XXS EC 4 in the warm-up phase	Wait until warm-up time is complete.
<b>653</b>	EC 4 concentration has drifted into the negative range	Conduct the fresh air calibration page 18.
<b>654</b>	The temperature is too high	Operate the instrument within the allowed temperature range.
<b>655</b>	The temperature is too low	Operate the instrument within the allowed temperature range.
<b>656</b>	The calibration interval for DrägerSensor XXS EC 4 has elapsed	Run sensitivity calibration for DrägerSensor XXS EC 4, page 19.
<b>657</b>	Alarm threshold A2 is set to greater than 60 %LEL	Set alarm threshold to less than 60 %LEL.

## 8.2 Fault message

Special symbol » ☒ « and displayed numerical code:	Cause	Remedy
102	The customer's service life counter has elapsed	Reset the service life counter using Dräger CC Vision.
103	The instrument is defective	The instrument must be repaired by Service.
104	Check sum error program code	The instrument must be repaired by Service.
105	Bump test interval elapsed	Run the bump test page 14.
106	The calibration interval has elapsed (at least 1 calibration interval has elapsed)	Run sensitivity calibration, see page 19 and/or page 19.
107	Bump test error (at least 1 channel has a bump test error)	Run bump test, page 14 or run sensitivity calibration, page 19 and/or page 19.
108	The instrument is defective	The instrument must be repaired by Service.
109	The menu function cannot be carried out because of an error	Determine the error code via the info menu and switch it off, if necessary.
111	Faulty alarm element test: Alarm light	Repeat alarm element test using X-dock.
112	Faulty alarm element test: Alarm horn	Repeat alarm element test using X-dock.
113	Faulty alarm element test: Vibration motor	Repeat alarm element test using X-dock.
114	Defective parameter check	Correct parameters and repeat test using X-dock
115	Instrument deactivated by X-dock	Instrument activated using X-dock.
116	Faulty software update	The instrument must be repaired by Service.
117	User parameters not feasible	Check configuration of user parameters and adjust

201	No valid zero point calibration of the DrägerSensor CatEx 125 PR	Conduct the fresh air calibration page 18.
202	No valid sensitivity calibration of the DrägerSensor CatEx 125 PR	Run sensitivity calibration, see page 19 and/or page 19.
203	Measurement from DrägerSensor CatEx 125 PR is in negative range	Conduct the fresh air calibration page 18.
204	DrägerSensor CatEx 125 PR not plugged in or faulty	Check DrägerSensor CatEx 125 PR, page 21
205	Error during bump test of DrägerSensor CatEx 125 PR	Repeat bump test, where necessary, calibrate or replace the DrägerSensor CatEx 125 PR, page 21.
207	Faulty rise time test	Repeat rise time test using X-dock.
208	User parameters not feasible	Check configuration of user parameters and adjust
218	Blocking alarm not plausible.	Calibrate the sensor.
221	Too little oxygen to operate the DrägerSensor CatEx 125 PR	Operate sensor in an environment with at least 8 vol. % O <sub>2</sub> .
222	No valid zero point calibration of the DrägerSensor CatEx 125 PR for heat conduction	Conduct the fresh air calibration page 18.
223	No valid sensitivity calibration of the DrägerSensor CatEx 125 PR for heat conduction	Run heat conduction sensitivity calibration, see page 19 and/or page 19.
224	Instrument incorrectly configured by Dräger CC-Vision.	Change sensor for applicable channel with Dräger CC-Vision.

301	No valid zero point calibration of the Dräger Sensor XXS EC1	Conduct the fresh air calibration page 18.
302	No valid sensitivity calibration of the Dräger Sensor XXS EC1	Run sensitivity calibration, see page 19 and/or fresh air calibration, page 18.
303	The measured value of DrägerSensor XXS EC 1 is in the negative range	Conduct the fresh air calibration page 18.
304	DrägerSensor XXS EC1 is not inserted or faulty	Check Dräger Sensor XXS EC1, page 21.



Special symbol » ☒ « and displayed numerical code:	Cause	Remedy
305	Error in bump test of Dräger Sensor XXS EC1	Repeat bump test, calibrate or replace DrägerSensor XXS EC1, if necessary page 21.
306	Faulty filter test	Repeat filter test using X-dock.
307	Faulty rise time test	Repeat rise time test using X-dock.
308	User parameters not feasible	Check configuration of user parameters and adjust
324	Instrument incorrectly configured by Dräger CC-Vision.	Change sensor for applicable channel with Dräger CC-Vision.
326	Error during warm-up acceleration Dräger Sensor XXS EC1	Disconnect and reconnect power pack or replace the sensor. Sensor must not be loaded with gas within the first 5 minutes.

401	No valid zero point calibration of the Dräger Sensor XXS EC2	Conduct the fresh air calibration page 18.
402	No valid sensitivity calibration of the Dräger Sensor XXS EC2	Run sensitivity calibration, page 19.
403	The measured value of DrägerSensor XXS EC2 is in the negative range	Conduct the fresh air calibration page 18.
404	DrägerSensor XXS EC2 is not inserted or faulty	Check Dräger Sensor XXS EC2, page 21.
405	Error in bump test of Dräger Sensor XXS EC2	Repeat function test, calibrate or replace Dräger Sensor XXS EC2, if necessary page 21.
406	Faulty filter test	Repeat filter test using X-dock.
407	Faulty rise time test	Repeat rise time test using X-dock.
408	User parameters not feasible	Check configuration of user parameters and adjust
424	Instrument incorrectly configured by Dräger CC-Vision.	Change sensor for applicable channel with Dräger CC-Vision.
426	Error during warm-up acceleration Dräger Sensor XXS EC2	Disconnect and reconnect power pack or replace the sensor. Sensor must not be loaded with gas within the first 5 minutes.

501	No valid zero point calibration of the Dräger Sensor XXS EC3	Conduct the fresh air calibration page 18.
502	No valid sensitivity calibration of the Dräger Sensor XXS EC3	Run sensitivity calibration, page 19.
503	The measured value of DrägerSensor XXS EC3 is in the negative range	Conduct the fresh air calibration page 18.
504	DrägerSensor XXS EC3 is not inserted or faulty	Check Dräger Sensor XXS EC3, page 21.
505	Error in bump test of Dräger Sensor XXS EC3	Repeat bump test, calibrate or replace DrägerSensor XXS EC3, if necessary page 21.
506	Faulty filter test	Repeat filter test using X-dock.
507	Faulty rise time test	Repeat rise time test using X-dock.
508	User parameters not feasible	Check configuration of user parameters and adjust
524	Instrument incorrectly configured by Dräger CC-Vision.	Change sensor for applicable channel with Dräger CC-Vision.
525	No valid sensitivity calibration for the compensation channel	Carry out span calibration for compensation electrode.
526	Error during warm-up acceleration Dräger Sensor XXS EC3	Disconnect and reconnect power pack or replace the sensor. Sensor must not be loaded with gas within the first 5 minutes.

601	No valid zero point calibration of the Dräger Sensor XXS EC4	Conduct the fresh air calibration page 18.
602	No valid sensitivity calibration of the Dräger Sensor XXS EC4	Run sensitivity calibration, page 19.

Special symbol » ☒ « and displayed numerical code:	Cause	Remedy
603	The measured value of Dräger Sensor XXS EC4 is in the negative range	Conduct the fresh air calibration page 18.
604	DrägerSensor XXS EC4 is not inserted or faulty	Check Dräger Sensor XXS EC4, page 21.
605	Error in bump test of Dräger Sensor XXS EC4	Repeat bump test, calibrate or replace DrägerSensor XXS EC4, if necessary page 21.
606	Faulty filter test	Repeat filter test using X-dock.
607	Faulty rise time test	Repeat rise time test using X-dock.
608	User parameters not feasible	Check configuration of user parameters and adjust
624	Instrument incorrectly configured by Dräger CC-Vision.	Change sensor for applicable channel with Dräger CC-Vision.
626	Error during warm-up acceleration Dräger Sensor XXS EC4	Disconnect and reconnect power pack or replace the sensor. Sensor must not be loaded with gas within the first 5 minutes.

## 9 Maintenance

### 9.1 Maintenance table

The instrument should be inspected and maintained by suitably qualified persons annually. Consult:

- EN 60079-29-2 – Guide for the selection, installation, use and maintenance of apparatus for the detection and measurement of combustible gases or oxygen
- EN 45544-4 – Electrical apparatus used for the direct detection and direct concentration measurement of toxic gases and vapours - Part 4: Guide for selection, installation, use and maintenance
- national regulations

Recommended calibration interval for measuring channels Ex, O<sub>2</sub>, H<sub>2</sub>S and CO: 6 months.



#### NOTICE

Calibration intervals of other gases: see Instructions for Use of the respective DrägerSensors.

- Depending on instrument configuration:
  - Replace the alkaline batteries or charge the battery – see section 3.1.2 on page 9 – after each use, at the latest after the battery alarm has been triggered or after 2 weeks.
- Calibrating the instrument – see section 5 on page 18.
  - At regular intervals, according to the sensors used and the operating conditions. For sensor-specific calibration data, refer to the Instructions for Use/data sheets of the sensors used<sup>1</sup>.
  - Before you carry out safety-related relevant measurements, the zero point and sensitivity of the instruments should be tested in accordance with national regulations.
- Inspection by suitably qualified persons – every year.
  - The inspection intervals must be established in each individual case and shortened if necessary, depending on technical safety considerations, engineering conditions, and the technical requirements of the equipment.
  - We recommend that a service agreement be concluded with Dräger and that repairs also be carried out by them.
- Replace the sensors, page 21 – if necessary, when it is not possible to calibrate the sensors any more.

### 9.2 Cleaning



#### CAUTION

Abrasive cleaning implements (brushes etc.), cleaning agents and cleaning solvents can destroy the dust and water filters.

- The instrument does not need any special care.
- Dirt and deposits can be removed from the instrument by washing it with cold water. A sponge can be used for wiping if necessary.
- Carefully dry the instrument with a cloth.

<sup>1</sup> Instructions for use/data sheets for the Dräger sensors can be downloaded from the product page for the X-am 2500 on the following website: [www.draeger.com](http://www.draeger.com). See also the enclosed instructions for use and data sheets for the sensors used.

## 10 Storage

- Dräger recommends storing the instrument in the charger module (order no. 83 18 639).
- Dräger recommends checking the charge of the power supply at least every three weeks if the instrument is not stored in the charger module.

## 11 Disposal

Dispose of product in accordance to applicable regulations.

### 11.1 WEEE



In accordance with EU Directive 2002/96/EC this product must not be disposed of as household waste. This is indicated by with the adjacent icon.

You can return this product to Dräger free of charge. For information please contact the national marketing organisations and Dräger.

### 11.2 Battery disposal



In accordance with EU Directive 2006/66/EC, batteries and rechargeable batteries must not be disposed of as household waste but must be taken to battery collection centres. This is indicated by the adjacent icon. Collect batteries and rechargeable batteries as specified by the applicable regulations and dispose of at battery collection centres.

### 11.3 Electrochemical sensors



#### WARNING

Acid burn risk!  
Do not throw into fire or open with force.



As with batteries, dispose of as special waste in line with local waste disposal regulations. Further information can be obtained from the relevant local authority and from appropriate waste disposal companies.

The DrägerSensor CatEx 125 PR should be disposed of as electronics waste.

## 12 Technical data

### 12.1 X-am 2500

<b>Ambient conditions:</b>	
during operation and storage	–20 to +50 °C for NiMH power pack type: HBT 0000 and HBT 0100, and for alkaline single cell type: Duracell Procell MN 1500 <sup>1</sup> –20 to +40 °C for NiMH single cell type: GP 180AAHC <sup>1</sup> and for alkaline single cell type: Panasonic LR6 Powerline 0 to +40 °C for alkaline single cell type: Varta 4006 <sup>1</sup> , Varta 4106 <sup>1</sup>
	700 to 1300 hPa
	10 to 90 % (short-term up to 95 %) relative humidity
Storage time	
X-am 5000	1 year
Sensors	1 year
Position of use	any
<b>Instrument data</b>	
Protection class	IP 67 for instruments with sensors
Alarm volume	Typically 90 dB (A) at 30 cm distance
<b>Operating time:</b>	
Alkaline battery	Typically 12 hours under normal conditions
NiMH power pack:	
T4 (type HBT 0000)	Typically 12 hours under normal conditions
T4 HC (type HBT 0100)	Typically 13 hours under normal conditions
Dimensions	approx. 130 mm x 48 mm x 44 mm (H x W x D)
Weight	approx. 220 g to 250 g
Refresh interval for display and 1 s signals	

1) Not subject to BVS10 ATEX E 080X and PFG 10 G 001X performance approval.

## 12.2 Sensor data

Extract! For details, see the data sheets for the sensors used (Instructions for use/data sheets for the Dräger sensors can be downloaded from the product page for the X-am 2500 on the following website: [www.draeger.com](http://www.draeger.com))

	Ex	XXS O <sub>2</sub>	XXS H <sub>2</sub> S-LC	XXS CO
Measuring principle	Catalytic oxidation	Electrochemical	Electrochemical	Electrochemical
Measurement value configuration time $t_{0..0.90}$	≤17 seconds for methane ≤25 seconds for propane	≤10 seconds	≤18 seconds	≤25 seconds
Measurement value configuration time $t_{0..50}$	≤7 seconds for methane ≤40 seconds for nonane <sup>1</sup>	≤6 seconds	≤6 seconds	≤6 seconds
Measuring range	0 to 100 %LEL <sup>2</sup> 0 to 5 vol. % for methane	0 to 25 vol. %	0 to 100 ppm H <sub>2</sub> S <sup>3</sup>	0 to 2000 ppm CO <sup>4</sup>
Zero error (EN 45544)	---	---	0.4 ppm	6 ppm
Instrument drift	---	---	≤1 % of measured value/month	≤1 % of measured value/month
Warm-up time	35 seconds	≤5 minutes	≤5 minutes	≤5 minutes
Effect of sensor poisons Hydrogen sulphide H <sub>2</sub> S, 10 ppm	≤1 %LEL/ 8 hours	---	---	---
Halogenated hydrocarbons, heavy metals, substances containing silicone, sulphur or polymerisable substances	Poisoning possible	---	---	---
Linearity error	≤5 %LEL	≤0.3 vol. %	≤2 % of the measured value	≤3 % of the measured value
Standards (Measuring function for explosion protection and measurement of oxygen deficiency and surplus as well as toxic gases, DEKRA EXAM GmbH, Essen, Germany: BVS 10 ATEX E 080X <sup>2)</sup> , PFG 10 G 001X	EN 60079-29-1 <sup>5</sup> EN 50271	EN 50104 <sup>6</sup> (measurement of oxygen deficiency and oxygen surplus) EN 50271	EN 45544-1/-2 <sup>7</sup> EN 50271	EN 45544-1/-2 <sup>8</sup> EN 50271
Cross sensitivities <sup>9</sup>	Fitted	Fitted	Fitted	Fitted

	<b>XXS NO<sub>2</sub></b>	<b>XXS SO<sub>2</sub></b>
Measuring principle	Electrochemical	Electrochemical
Measurement value configuration time $t_{0..0.90}$	≤15 seconds	≤15 seconds
Measurement value configuration time $t_{0..50}$	---	---
Measuring range	0 to 50 ppm NO <sub>2</sub>	0 to 100 ppm SO <sub>2</sub>
Zero error	0.2 ppm	0.1 ppm
Instrument drift	≤2 % the measuring value/month	≤2 % the measuring value/month
Warm-up time	≤5 minutes	≤5 minutes
Effect of sensor poisons Hydrogen sulphide H <sub>2</sub> S, 10 ppm halogenated hydrocarbons, heavy metals, gases containing silicone, sulphur or polymerizable substances	---	---
Linearity error	≤±2 % of the measured value	≤±2 % of the measured value
Standards (Measuring function for explosion protection and measurement of oxygen deficiency and surplus as well as toxic gases, DEKRA EXAM, Essen, Germany: BVS 10 ATEX E 080X <sup>2)</sup> , PFG 10 G 001X	---	---
Cross sensitivities <sup>8)</sup>	Fitted	Fitted

- 1) For decreasing concentrations, the adjustment time for nonane is about 50 seconds.
- 2) For alkanes from methane to nonane, LEL-values in accordance with EN 60079-20-1. For flow speeds of 0 to 6 m/s the deviation of the display can be 5 - 10 % of the measuring value. For an adjustment to propane, the deviation of the display in the range of 80 to 120 kPa can be up to 6 %LEL.
- 3) Certified for 0.4 to 100 ppm
- 4) Certified for 3 to 500 ppm
- 5) The instrument responds to most combustible gases and vapours. The sensitivities differ depending on the type of gas. We recommend a calibration using the target gas to be measured. For the range of alkanes, the sensitivity decreases from methane to nonane.
- 6) The measuring signals may be negatively affected by ethane, ethene, ethyne, carbon dioxide and hydrogen.
- 7) The measuring signals may be additively affected by sulphur dioxide, nitrogen dioxide and hydrogen, and negatively affected by chlorine.
- 8) The measuring signals can be affected additively by acetylene, hydrogen and nitrogen monoxide.
- 9) A table of the cross sensitivities is contained in the Instructions for Use or the data sheet of the respective sensor.

### 13 Order list

Name and description	Order no.
<b>Dräger X-am 2500</b> Unlimited 1 to 4 multi gas monitors with exchangeable sensors. With selectable special calibration. Standard calibration for the ex-sensor: methane. Including country-specific adjustable standard alarm thresholds.	
<b>Dräger X-am 2500 standard instrument:</b>	
Dräger X-am 2500 Ex	83 23 910
Dräger X-am 2500 Ex, O <sub>2</sub>	83 23 912
Dräger X-am 2500 Ex, O <sub>2</sub> , H <sub>2</sub> S LC	83 23 914
Dräger X-am 2500 Ex, O <sub>2</sub> , CO	83 23 916
Dräger X-am 2500 Ex, O <sub>2</sub> , CO, H <sub>2</sub> S LC	83 23 918
<b>Basic instrument with selectable special calibrations, including a calibration certificate</b>	83 23 900
<b>Power supply units:</b>	
NiMH power pack T4 (type HBT 0000)	83 18 704
NiMH power pack T4 HC (type HBT 0100)	83 22 244
Battery holder ABT 0100	83 22 237
Alkaline batteries T3 (2 pcs) <sup>1</sup>	83 22 239
Alkaline batteries T4 (2 pcs) <sup>1</sup>	83 22 240
Rechargeable battery and charging kit (contains NiMH power pack T4, charging module for Dräger X-am 1/2/5000 and plugin power pack)	83 18 785
<b>Chargers:</b>	
Charging module for Dräger X-am 1/2/5000	83 18 639
Power pack with connecting cord (worldwide) for a maximum of 20 charging modules Dräger X-am 1/2/5000	83 15 805
Power pack (worldwide) for a maximum of 5 charging modules Dräger X-am 1/2/5000	83 16 994
Power pack (worldwide) for a maximum of 2 charging modules Dräger X-am 1/2/5000	83 15 635
Vehicle connecting line 12 V/24 V for Dräger X-am 1/2/5000 charging module	45 30 057
Vehicle installation set for 1 Dräger X-am 1/2/5000 charging module	83 18 779
<b>Accessories</b> The accessories are not included in BVS10 ATEX E 080X and PFG 10 G 001X.	
<b>Pump accessories:</b>	
Dräger Pump X-am 1/2/5000	83 19 400
Case for Dräger Pump X-am 1/2/5000	83 19 385
Rubber ball pump	68 01 933
Manual pump adapter	83 19 195
Dust and water filter	83 13 648

Name and description	Order no.
<b>Extension hoses and probes:</b>	
Measuring probe 0.5 m	64 08 238
Measuring probe 1.5 m	64 08 239
Plug-in telescopic probe	68 01 954
Telescopic probe 100 with accessories	83 16 530
Telescopic probe 150 stainless steel	83 16 533
Tester 90	83 16 532
Float probe with accessories	83 18 371
Viton hose	12 03 150
Hose	11 80 681
<b>Accessories for measured value acquisition and configuration:</b>	
Dräger GasVision	83 14 034
USB DIRA with USB cable (USB infrared adaptor for communication Dräger X-am 1/2/5000 – PC)	83 17 409
<b>Calibration/adjustment accessories:</b>	
Dräger X-dock, e.g. X-dock 5300 X-am 125	83 21 880
Bump Test Station, including mixed gas cylinder	83 19 130
E-Cal module Dräger X-am 1/2/5000	83 18 754
Calibration cradle Dräger X-am 1/2/5000	83 18 752
Mixed gas cylinder 2.5 vol. % CH <sub>4</sub> , 18 vol. % O <sub>2</sub> , 15 ppm H <sub>2</sub> S, 50 ppm CO	68 11 130
Test gas cylinder propane, 0.9 vol. % C <sub>3</sub> H <sub>8</sub> in air	68 11 118
On demand regulator	83 16 556
Standard regulator	68 10 397
<b>Other accessories:</b>	
Protective case for Dräger X-am 1/2/5X00	83 21 506
Carrying bag	83 18 755
<b>Spare parts</b>	
DrägerSensor CatEx 125 PR, 0 to 100 %LEL	68 12 950
DrägerSensor XXS O <sub>2</sub> , 0 to 25 vol. % <sup>2</sup>	68 10 881
DrägerSensor XXS CO, 0 to 2000 ppm <sup>1)</sup>	68 10 882
DrägerSensor XXS H <sub>2</sub> S LC, 0 to 100 ppm <sup>1)</sup>	68 10 883
DrägerSensor XXS NO <sub>2</sub> , 0 to 50 ppm	68 10 884
DrägerSensor XXS SO <sub>2</sub> , 0 to 100 ppm	68 10 885

- 1) Not subject to the Metrological Performance Test BVS10ATEXE080X and PFG10G001X.  
2) Expected service life of the sensors: O<sub>2</sub> and CO >5 years, CatEx > 3 years.